

SCHIEDEL

RITE-VENT



Prima Plus Prima Plus 1mm Prima SW

80 - 755mm Diameter Range

Single wall stainless steel flue systems
for gas, oil, wood and multi-fuel.

- Residential & commercial applications
- Fluing condensing boilers
- Relining existing chimneys for stoves, boilers or open fires
- Connection between stoves or boilers and chimneys
- Venting warm air gas and oil heaters and for particle/fume extraction systems



Prima 80/755 LIT DOC/CP03/45 Issue 3 February 2007

A company of **LAFARGE**
ROOFING

Application

Prima Plus is a high quality 316L stainless steel single wall flue system with a wall thickness of 0.6mm. It is designed for use on gas and oil burning stoves and boilers with continuous operating temperatures up to 450°C and short firing up to 600°C. With the addition of a gasket to the joint, Prima Plus is designed for fluing condensing gas and oil appliances with positive pressures up to 200Pa, continuous operating temperatures up to 160°C and short firing up to 200°C. It can also be used for lining brick stacks for gas, oil, multi-fuel appliances and open fires as an alternative to flexible liner. (The exception is in England where Building Regulations now disallow the use of 0.6mm as a liner in domestic installations).

Prima Plus 1mm can be used for the same applications as Prima Plus. Additionally it is specifically designed for connecting solid fuel appliances to existing brick stacks or a twin wall chimney. It provides internal fluing of domestic woodburning, coal and multi-fuel stoves and boilers with normal operating temperatures up to 540°C and short firing up to 760°C.

Prima SW is a medium corrosion-resistant 304 BA grade stainless steel single wall flue system designed for use internally on gas and oil-fired (28 sec only) air and ceiling heaters and natural draught boilers with constant operating temperatures up to 250°C.

Product Description

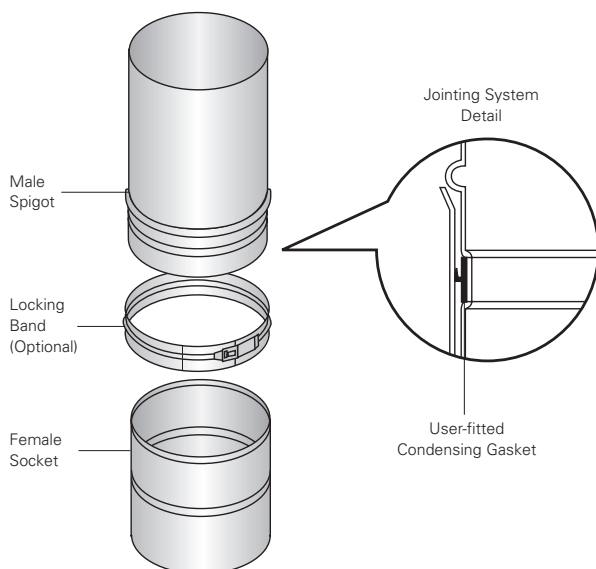

Prima Plus

- Advanced corrosion-resistant design and construction using 0.6mm 316L continuously-welded stainless steel. The only stainless steel system to have passed the internationally-recognised GASTEC corrosion test.
- Engineered-tolerance joint simply push-fits together giving exceptional load bearing capacity. Optionally, a locking band can be fitted for extra joint security.
- Inward bead on the male joint spigot acts as a capillary break preventing moisture being drawn through the joint.
- Adjustable 0-90° elbows quickly solve alignment problems on installation of flue runs.
- Can be painted if required.
- For condensing appliances a gasket is fitted to the inward bead of the male joint.

Prima Plus 1mm

- Identical construction and features to Prima Plus but made from 1.0mm 316L stainless steel.
- Use as an alternative to vitreous enamelled flue pipe, painted if required.

Prima SW

- Identical design and construction to Prima Plus but is manufactured from economical 0.5mm and 0.6mm 304BA medium corrosion resistant stainless steel.
- Not for use with condensing appliances.

Approvals

Prima Plus Connecting Flue Pipe is CE Certified to EN 1856-2 TUV 0036 CPD 9195 017 with designations T600 N1 W V2 L50060 G(400), T200 H1 W V2 L50060 O(200), T200 P1 W V2 L50060 O(200) and T200 N1 W V2 L50060 O(200).

Single Wall System Chimney according to EN 1856-1 TUV 0036 CPD 9195 018, T600 N1 W V2 L50060 G(70).

Chimney Liner according to EN 1856-2 TUV 0036 CPD 9195 019, T600 N1 W V2 L50060 G and T200 P1 W V2 L50060 O.

The Prima range is manufactured under the strict requirements of BS EN ISO 9001:2000 Quality management scheme.

Prima Plus has corrosion certification from Gastec, MPA and TUV.

Prima Plus 1mm is listed by HETAS as a chimney suitable for solid fuel.

Corrosion Resistance

Chimneys are subject to significant corrosion attack by flue gas condensates, particularly from solid fuel heavy oils and condensing appliances. Prima Plus and Prima Plus 1mm are specifically designed and manufactured to resist this corrosion. It is the only stainless steel single wall chimney system in the world to have passed the internationally recognised Gastec corrosion test.

Flue Size Selection Guide

The chimney size should be as recommended by the appliance manufacturer. Where there is a requirement for a flue diameter smaller than the appliance spigot, then the operational requirements of the appliance and the configuration of the flue must satisfy the flue sizing requirements of DIN4705 (commercial only). For more information contact the installer helpline. The information and sizes below are provided as a nominal guide only. Flue sizing for appliances, particularly commercial/industrial applications, will vary depending on siting details and appliance manufacturer's instructions and design criteria. These will override the sizing guide and reference

	80 mm	100 mm	130 mm	150 mm	180 - 400mm
Gas - Atmospheric Boiler					
Input up to 25kw		•			
Input 25kw to 40kw			•		
Input 40kw to 60kw				•	
Gas - Commercial/Ind. Boiler					
Input 50kw to 70kw					•2
Gas Fires					
'Radiant' to BS7977-1 2002			•		
'Inset' to BS7977-1 2002			•1		•1
'Backboiler' to BS7977-2 2003			•		
Gas Water Heaters					
Input up to 25kw	•	•			
Input 25kw to 55kw			•		
Input 55kw to 60kw				•	
Input over to 60kw					•2
Gas Warm Air Unit					
Input up to 18kw		•			
Input 18kw to 35kw			•		
Input 35kw to 60kw				•	
Input over to 60kw					•2
Gas Stove/Cooker		•2	•2	•2	
Kerosene (28sec Class C2)					
Heating Boiler					
Output up to 25kw		•			
Output 25kw to 45kw			•		
Output 45kw to 70kw				•	
Kerosene Stove/Cooker		•3	•3	•3	
Kerosene Water Heater					
Input up to 41kw				•	
Kerosene Visual Effect Stove					
Output up to 17kw		•3	•3		

guide and reference must be made to the appliance manufacturer. For Inglenook and non-standard openings, the diameter of the flue must be at least 15% of the cross sectional area of the fireplace opening.

Technical Data

	Prima Plus	Prima Plus (Condensing)	Prima Plus SW
Fuel	Gas, oil, wood, coal	Gas, oil	Gas
Continuous Firing Temp	450° C	200° C	250°C
Short Firing Temp	600° C	-	300°C
Thermal Shock	1000° C	-	-
Mode of Operation	Zero & Negative Pressure	Zero, Negative & Positive Pressure	Zero & Negative Pressure
Pressure Capabilities	100Pa	200Pa	40Pa
Seam	Laser or Inert Gas Welded		
Liner Thickness (mm)	P+ 0.6mm P+1 1.0mm	P+ 0.6mm P+1 1.0mm	0.5mm & 0.6mm
Liner Material	316L : 1.4404 : X2CrNiMo 17-12-2		304:1.4301:X5CRNI 18-10

	100 mm	130 mm	150 mm	180 mm	200 mm	230 mm	250 - 400mm
Gas Boiler - Forced Draught							
Input up to 25kw	•						
Input 25kw to 45kw		•					
Input 45kw to 50kw			•				
Input 50kw to 75kw				•			
Input 75kw to 100kw					•		
Input over to 100kw						•	•2
Gas Fires							
'Inset' to BS7977-1 2002				•1			
'Decorative' BSEN 509:2000				•			
Gas Oil (35sec Class D)							
Heating Boiler							
Output up to 25kw	•						
Output 25kw to 45kw		•					
Output 45kw to 70kw			•				
Output 70kw to 100kw				•			
Output over 100kw					•3	•3	•3
Solid Fuel							
Heating Boiler							
Input up to 20kw			•S	•SC			
Input 20kw to 30kw				•S	•SC	•SC	
Input 30kw to 60kw					•SC	•SC	•SC
Open Fires (standard opening)							
500mm x 550mm					•	200 min	
Avant Garde Feature Open Fires							•4
Room Heaters			•S				
Wood burning stoves and cookers			•	•			
Use only seasoned wood.				200min			
Inglenook/ non-standard opening							
Flue size dependant on cross-sectional area of fireplace opening.							•
							230min

Notes: 1 Subject to appliance manufacturer's testing criteria. 2 Subject to manufacturer's input rating and chimney height. 3 Subject to manufacturer's output rating and chimney height. 4 Min 300mm depending on opening, chimney size and height. S Smokeless fuel only. SC Smokeless fuel or coal.

System Design

Restrictions on use of Single Wall Flue

The Prima range is principally intended for internal use and to reline existing chimneys. Its siting is governed by the requirements of CE, BS7566 and the Building Regulations. When single wall flue is used to connect an appliance in domestic situations, eg stove, BS 7566 Pt2 states that the connection onward from the appliance into the twin wall flue or brick chimney must be made within the same room as the appliance and not closer than 150mm to the ceiling/wall. A continuous run of Prima Plus is permitted when using it as a liner entering an existing chimney in the same room as the appliance. When connected to an appliance operating below 160°C eg a condensing boiler, Prima Plus may be run through floors or in an enclosed shaft provided that a minimum distance to combustibles of 200mm is maintained (400mm for diameters above 200mm). For external or exposed installations where there is a risk of condensate freezing, a twin wall insulated chimney such as ICS, ICID or KVent should be used. A twin wall insulated chimney additionally will keep the flue warmer and assist flue efficiency. To this end, Building Regulations Document J now requires all domestic external flue runs over 3m to be made in twin wall stainless steel lined insulated chimney.

Flue Routing

The chimney should remain as straight as possible through its vertical run to assist flow. Horizontal runs should be avoided or kept as short as possible. Should it be necessary to offset a chimney run the following guidelines should be adhered to:

Gas: An offset no greater than 45° to the vertical, with a run between the bends not exceeding half the overall height of the chimney should be maintained.

Oil - Solid Fuel: An offset no greater than 30° to the vertical, with a run between the bends not exceeding 20% of the overall height of the chimney should be maintained. In both instances a maximum of two bends in any one chimney run should be used. A vertical rise of 600mm should be allowed immediately above the appliance before any offsets. Reference for both guidelines can be found in the Building Regulations Doc J and relevant British Standards on installations.

Terminal Types

For solid fuel appliances, BS7566 Parts 1, 2, 3 and 4 recommends use of an open terminal for chimneys up to 200mm diameter. Rain ingress should not be significant, but drain components can be fitted. Above 200mm a covered terminal can be used, and for all oil and gas installations. Mesh carries the risk of sooting and requires regular cleaning to avoid blockage particularly with oil and solid fuel.

Provision for sweeping, cleaning and maintenance

Provision should be made for inspecting and cleaning the chimney. This is particularly important on solid fuel applications. It is recommended that chimneys serving solid fuel appliances be swept as frequently as necessary but at least twice a year. Choose an access component suitable for your installation unless cleaning/inspection can be done through the appliance.

It is essential that the flue way be kept clear at all times in the interest of good practise and health, safety and appliance performance. The system should be checked regularly during the appliance maintenance. (Refer appliance manufacturer's instructions). All as per HETAS Guide.

Multi fuel stove with Prima Plus 1mm

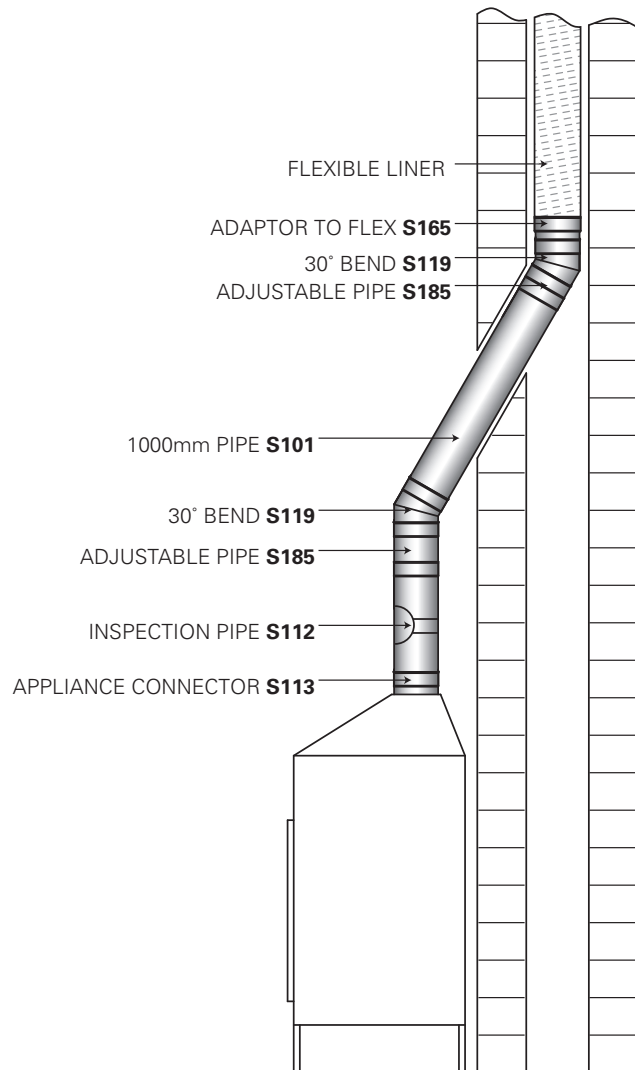

Room Ventilation

The room carrying the appliance should have an air vent either direct to an external air source or vented into a room that has an external vent direct to an air source. This is required to provide adequate air supply to allow the appliance and flue to operate efficiently. These requirements are specified in the Building Regulations (Document J) also by CIBSE and BS5440.

Commercial Installations

The Prima range is appropriate for use in a variety of commercial applications. Schiedel RiteVent can provide a full design and flue sizing advice service.

Provision for condensate disposal

(subject to appliance manufacturer recommendations)

Normally solid fuel and atmospheric gas and oil appliances will not need a drain unless rain ingress is significant. Most condensing appliances however need provision for drainage. As a rule of thumb a condensing boiler produces 1 to 1.5 litres of condensate per hour per 10kw of input. This is a significant amount of acidic liquid which must be drained from the system. Choose appropriate flue drainage components, normally fitted at the base of the stack and close to the appliance outlet. A 5° slope on horizontal runs is advised, using the appropriate 85° or 40° bend and 95° tee.

Relining of chimney with Prima Plus 1mm

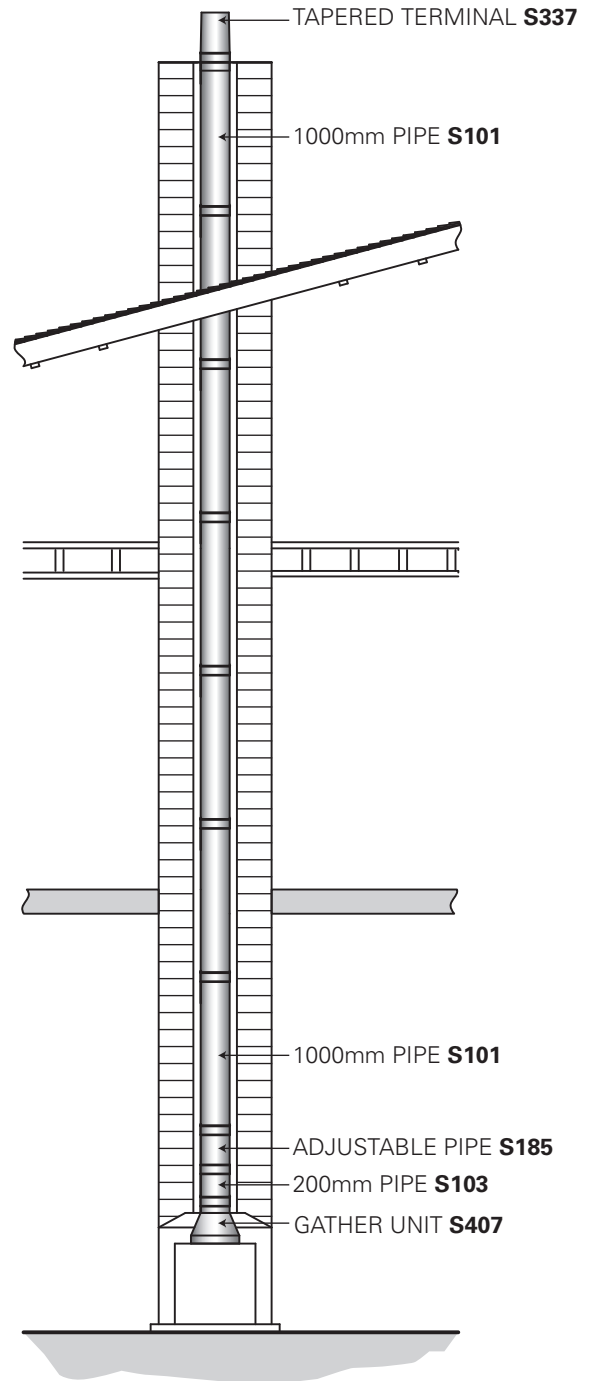

Suspended heater with Prima SW

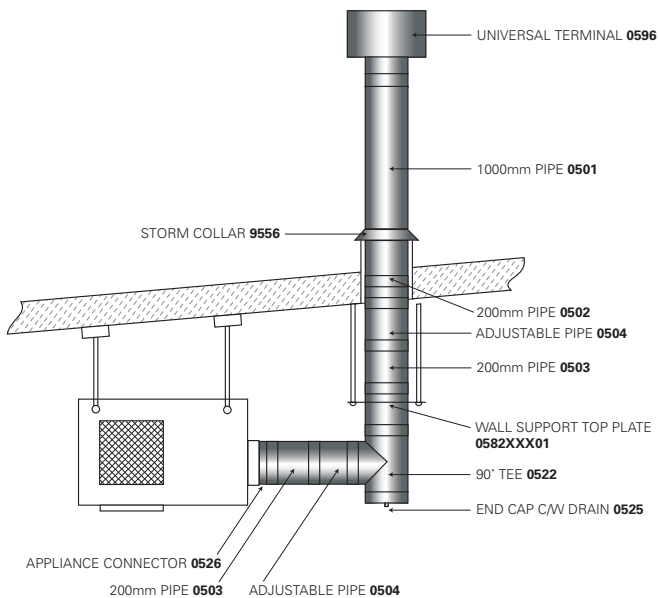

Diameters

The diameters (mm) of the flue are:

Int Ø	80	100	130	150	180	200	230	250	300	355	405	455	505	555	605	655	705	755
-------	----	-----	-----	-----	-----	-----	-----	-----	-----	-----	-----	-----	-----	-----	-----	-----	-----	-----

For reasons of space, the tables below only show dimensions up to 300mm Ø, which is the majority of usage.

Product Ordering

To identify fully the component required, it is necessary to state the product code followed by diameter e.g. for a 150mm diameter 0-90° Prima Plus 1mm bend the full code would be S105150.

Starting Components

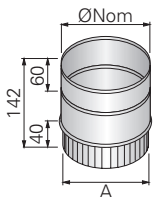

Appliance Connector

ØNom	80	100	130	150	180	200	230	250	300
------	----	-----	-----	-----	-----	-----	-----	-----	-----

'A' is 6mm less than nom

P+ S013
P+1 S113
PSW 0526

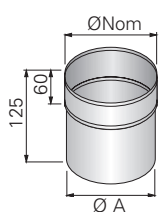

Condensing/Imperial Appliance Connector

ØNom	130	180
ØA	125	175

Smooth wall to fit inside spigot of condensing boilers which normally incorporate their own integral lip seal.

P+ S0A5
P+1 S413
PSW -

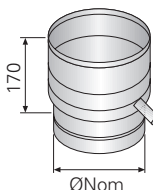

Vertical Drain

Nom Ø	100	130	150	180	200	230	250	300
-------	-----	-----	-----	-----	-----	-----	-----	-----

P+ S394
P+1 S494
PSW -

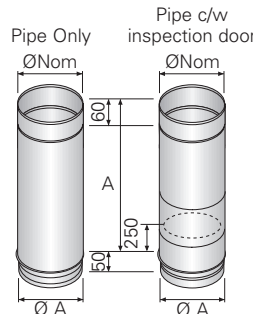

Imperial Starter Pipe

ØNom	130	180
ØA	125	175

A Pipe c/w insp.dr

A	Pipe	c/w insp.dr
950	S401	S405
450	S403	S406

P+ -
P+1mm
PSW -

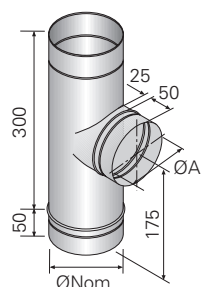

90° Starter Tee Imperial

ØNom	130	180
ØA	125	175

Used to connect to a horizontal outlet stove with an imperial (125 or 175mm) spigot.

P+ S315
P+1 S415
PSW -

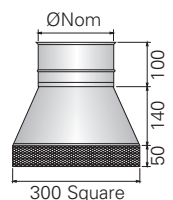

Gather Unit

ØNom	180	200
------	-----	-----

Used when lining a masonry chimney to seal to the fireplace throat

P+ S307
P+1 S407
PSW -

Adaptors/Increasers

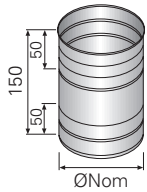

Double Male Adaptor

ØNom	80	100	130	150	180	200	230	250	300
------	----	-----	-----	-----	-----	-----	-----	-----	-----

50mm effective length

P+ S331
P+1 S431
PSW 0535

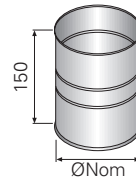

Double Female Adaptor

ØNom	80	100	130	150	180	200	230	250	300
------	----	-----	-----	-----	-----	-----	-----	-----	-----

30mm effective length

P+ S025
P+1 S425
PSW 0527

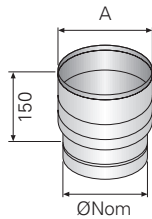

Increaser

Ø Nom	80	100	130	150	180	200	230	250
'A'	100	130	150	180	200	230	250	300

Standard is to increase to the next diameter, however any other diameter can be ordered specially.

P+ S091 + ØNom + A
P+1 S191 + ØNom + A
PSW 0571 + ØNom + A

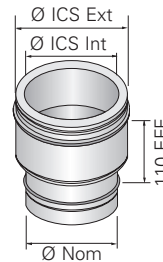

Adaptor to ICS

ØNom	80	80	80	80	100	100	100	100	130	130	130	150	150	150
ØInt	80	100	130	150	100	130	150	200	130	150	180	150	180	200
ØExt	130	150	180	200	150	180	200	250	180	200	230	200	230	250
ØNom	180	180	180	200	200	200	230	230	250	250	300	300	300	300
ØInt	180	200	250	200	230	250	230	250	250	300	300	355	405	455
ØExt	230	250	300	250	280	300	280	300	300	355	355	405	455	505

Other diameter combinations available on request.

P+ S068 + Nom + ICS Int
P+1 S168 + Nom + ICS Int
PSW 0536 + Nom + ICS Int

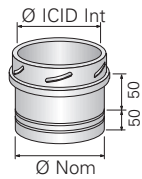

Adaptor to ICID

Nom Ø	150	180	200	250	300
'A'	150	180	200	250	300

Other diameter combinations available on request.

P+ S027 + Nom + Int
P+1 S127 + Nom + Int
PSW 0537 + Nom + Int

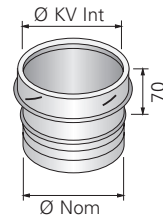

Adaptor to K-Vent

Nom Ø	150	180	200	250	300
'A'	150	180	200	250	300

Other diameter combinations available on request.

P+ S327 + Nom + Int
P+1 S427 + Nom + Int
PSW 0538 + Nom + Int

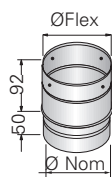

Adaptor to Flex/ Turboflex Plus

ØNom	80	100	130	130	150	180	200	230	250	300
ØFlex	80	100	125	130	155	180	200	230	250	300

Other diameter combinations available on request.

P+ S065 + Nom + ØFlex
P+1 S165 + Nom + ØFlex
PSW 0539 + Nom + ØFlex

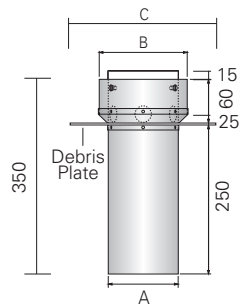

Turboflex Plus Adaptor & Debris Plate

ØNom	125	155	180	200
'A'	120	147	171	195
'B'	150	185	209	225
'C'	250	250	350	350

Used to connect a Prima Plus 1mm stove flue to a Turboflex Plus lined chimney. The tail fits inside the Prima+1mm and must be sealed with high temperature sealant. The debris plate fits onto a register plate or similar at the base of the chimney to provide support for the Turboflex Plus above.

P+ -
P+1 4024
PSW -

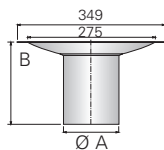

Sump Adaptor

ØNom	130	150	180	200
'A'	122	145	172	195
'B'	350	347	344	341

Used to connect a Prima+ stove flue to a register plate or similar, at the base of a chimney stack. The tail fits inside the Prima+, and must be sealed with high temperature sealant.

P+ S309
P+1 S409
PSW -

Pipes

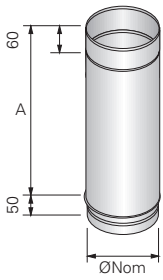

A 950 450 200
P+ S001 S002 S003
P+1 S101 S102 S103
PSW 0501 0502 0503

Effective Length

ØNom	80	100	130	150	180	200	230	250	300
------	----	-----	-----	-----	-----	-----	-----	-----	-----

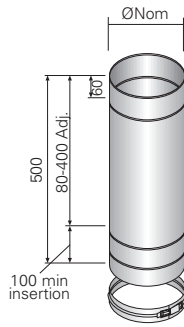

P+ S085
P+1 S185
PSW 0504

Adjustable Pipe

ØNom	80	100	130	150	180	200	230	250	300
------	----	-----	-----	-----	-----	-----	-----	-----	-----

Slides inside pipe below. Complete with locking band.
For condensing situations fit gasket S000 in the two grooves provided. This component is not load bearing.

Extended Locking Band

95840

ØNom	80	100	130	150	180	200	230	250	300
------	----	-----	-----	-----	-----	-----	-----	-----	-----

Use on horizontal runs to achieve 4m between supports. Also use to avoid guy wires and to achieve 3m unsupported above roof level by fitting to the joint immediately below and every joint above roof level.

Inspection Tee Non Condensing

P+ S010
P+1 S110
PSW 0513

ØNom	80	100	130	150	180	200	230	250	300
A	282	282	282	282	282	282	401	401	401
B	114	114	114	114	114	114	202	202	202
C	173	173	173	173	173	173	292	292	292
D	30	30	30	30	30	30	30	30	30

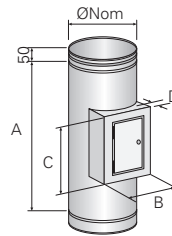

Lowering Pipe

P+ S333
P+1 S433
PSW 0533

ØNom	80	100	130	150	180	200	230	250	300
------	----	-----	-----	-----	-----	-----	-----	-----	-----

Used as the first pipe when lowering a liner into a masonry stack.

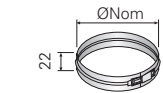
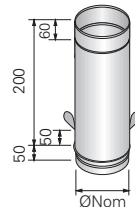

Locking Band

ØNom	80	100	130	150	180	200	230	250	300
------	----	-----	-----	-----	-----	-----	-----	-----	-----

P+ S030
P+1 S030
PSW 0583

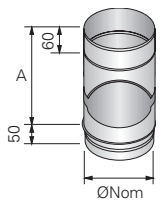
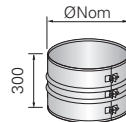

Inspection Pipe

ØNom	80	100	130	150	180	200	230	250	300
------	----	-----	-----	-----	-----	-----	-----	-----	-----

A 950 450 200
P+ S011 S012 S004
P+1 S111 S112 S104
PSW 0511 0512 -

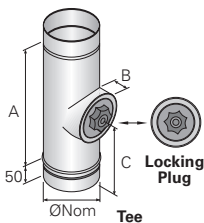

Inspection Tee Condensing

NomØ	80	100	130	150	180	200	230	250	300
A	195	215	245	265	295	315	355	365	415
B	10	10	10	10	10	10	30	30	30
C	120	130	145	165	170	180	195	205	230

Tee Locking Plug
P+ S075 S074
P+1 S175 S074
PSW - -

Order tee and locking plug separately.

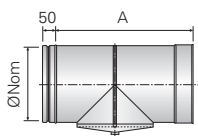

Horizontal Drain Point

ØNom	80	100	130	150	180	200
A	195	215	245	265	295	315

P+ S094
P+1 S194
PSW -

Gasket to Convert Prima Plus to Prima Plus Condensing

Fits into the groove form on all male spigots and into grooves on adjustable pipes



Silicon Gasket

S000 + Nom

ØNom	80	100	130	150	180	200	230	250	300
------	----	-----	-----	-----	-----	-----	-----	-----	-----



Viton Gasket

V000 + Nom

ØNom	80	100	130	150	180	200	230	250	300
------	----	-----	-----	-----	-----	-----	-----	-----	-----

For use on oil applications. To comply with the requirements of EN1856.1

Bends

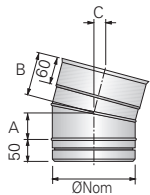

15° Bend

P+ S018
P+1 S118
PSW 0518

NomØ	80	100	130	150	180	200	230	250	300
A	30	32	34	35	37	38	40	41	45
B	85	87	89	90	92	93	95	96	100
C	22	22	23	23	24	24	25	25	26

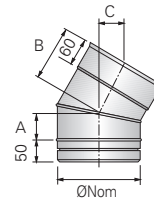

30° Bend

P+ S0C3
P+1 S119
PSW 0519

NomØ	80	100	130	150	180	200	230	250	300
A	36	38	42	45	49	52	56	58	65
B	91	93	97	100	104	107	111	113	120
C	45	47	49	50	52	53	55	57	60

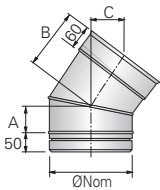

40° Bend

P+ S0B6
P+1 S452
PSW -

NomØ	80	100	130	150	180	200	230	250	300
A	49	53	49	52	58	61	67	70	80
B	105	109	104	107	113	116	122	125	135
C	68	70	67	68	72	75	78	81	87

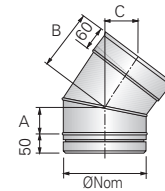

45° Bend

P+ S015
P+1 S115
PSW 0543

NomØ	80	100	130	150	180	200	230	250	300
A	52	56	52	56	62	66	73	77	87
B	107	111	107	111	117	121	128	132	142
C	75	78	75	78	83	86	90	93	100

Use with 45° bend or to create 85° total or 135° tee.

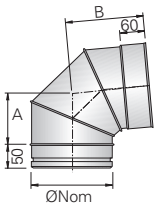

85° Fixed Bend

P+ S0C4
P+1 S1C4
PSW -

NomØ	80	100	130	150	180	200	230	250	300
A	88	97	115	126	126	135	150	159	181
B	143	152	166	176	177	186	199	208	232

Used to obtain 5° slope for condensing runs.

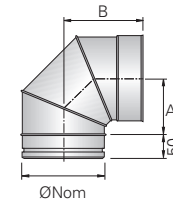

90° Fixed Bend

P+ S051
P+1 S151
PSW 0542

NomØ	80	100	130	150	180	200	230	250	300
A	92	102	104	114	129	139	154	164	189
B	147	157	159	169	184	194	209	219	244

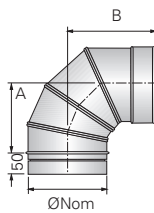

0-90° Adjustable Bend

P+ S005
P+1 S105
PSW 0515

NomØ	80	100	130	150	180	200	230	250	300
A	158	164	143	142	158	176	191	200	232
B	173	189	180	184	199	216	231	240	275

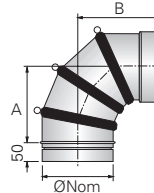

0-90° Adjustable Bend Condensing

P+ S006
P+1 S106
PSW -

NomØ	80	100	130	150	180	200
A	180	178	162	166	180	197
B	211	208	202	209	223	237

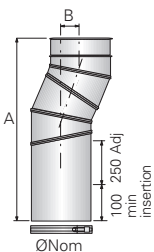

0-90° Adjustable Bend Extendable

P+ S084
P+1 S184
PSW 0584

NomØ	130	150	180	200	230	250	300
A	595	595	636	636	680	680	680
B	52	54	54	54	63	63	63

Tail slides inside pipe below. Secure with locking band provided. Not load bearing.

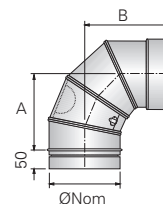

0-90° Adjustable Bend Inspection

Standard P+ S028
Extendable P+1 S0B1
P+1 S128 P+1 S1B1
PSW 0530 PSW 05B1

NomØ	80	100	130	150	180	200	230	250	300
A	177	177	143	142	158	176	191	200	289
B	205	205	180	184	199	216	231	240	246

Tees

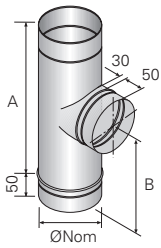

90° Tee

NomØ	80	100	130	150	180	200	230	250	300
A	195	215	245	265	295	315	345	365	415
B	120	130	145	155	170	180	195	205	230

P+ S014
P+1 S114
PSW 0522

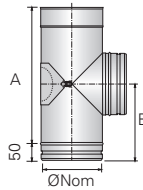

90° Inspection Tee

P+ S0A6
P+1 S1A6
PSW -

Dimensions as 90° Tee.

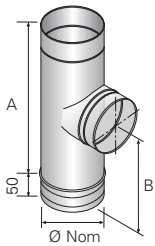

90° Tee Female Branch

P+ S0A3
P+1 S410
PSW -

A and B Dimensions as above.

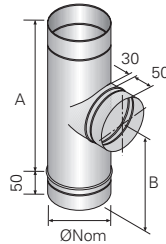

95° Tee

Used to create 5° slope on runs to assist drainage of condensate.

P+ S0A4
P+1 S417
PSW -

A and B Dimensions as above.

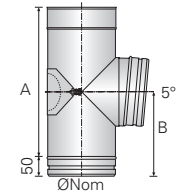

95° Tee Female Branch

P+ S0A7
P+1 S1A7
PSW -

A & B Dimensions as above.

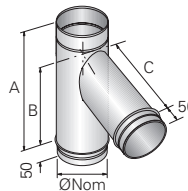

135° Tee

NomØ	80	100	130	150	180	200	230	250	300
A	223	251	294	322	365	393	435	464	534
B	127	151	188	212	248	272	308	332	393
C	127	151	188	212	248	272	308	332	393

P+ S016
P+1 S116
PSW 0521

90° Reducing Tee

P+ S008 + Nom + A
P+1 S108 + Nom + A
PSW 0531 + Nom + A

95° Reducing Tee

P+ S0B2 + Nom + A
P+1 S1B2 + Nom + A
PSW -

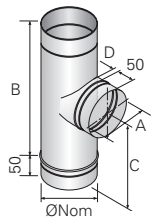

NomØ	100	130	130	150	150	180	200	200	200	230	230	230	230	250	250	250	250	250	300	300	300	300
'A'	80	80	100	100	80	100	80	100	130	80	100	130	150	80	100	130	150	80	100	130	150	200
'B'	200	200	200	200	200	200	200	200	245	200	200	245	265	200	200	245	265	200	200	245	265	315
'C'	125	125	125	125	125	125	125	125	145	125	125	145	155	125	125	145	155	125	125	145	155	180
'D'	25	45	45	45	45	45	45	45	30	45	45	30	30	45	45	30	30	45	30	30	30	30

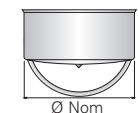

Tee Plug

ØNom	80	100	130	150	180	200	230	250	300
------	----	-----	-----	-----	-----	-----	-----	-----	-----

P+ S017
P+1 S017
PSW 0524

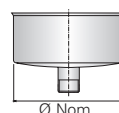

Tee Plug with Drain

ØNom	80	100	130	150	180	200	230	250	300
------	----	-----	-----	-----	-----	-----	-----	-----	-----

P+ S019
P+1 S019
PSW 0525

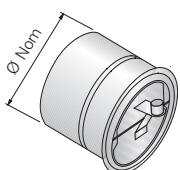

Draught Stabiliser

ØNom	80	100	130	150	180	200	230	250	300
------	----	-----	-----	-----	-----	-----	-----	-----	-----

P+ S078
P+1 S178
PSW 0595

Support Components

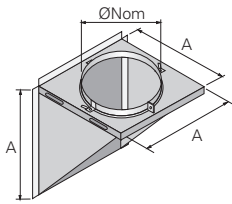

Wall Support Adjustable 50-125mm

P+ S0A8
P+1 S0A8
PSW 05A8

ØNom	80	100	130	150	180	200	230	250	300
A	180	200	230	250	280	300	330	350	400

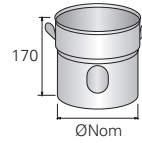

Drain Support

S330

ØNom	80	100	130	150	180	200	230	250	300
------	----	-----	-----	-----	-----	-----	-----	-----	-----

Used as a method of resting a tee plug and drain at the base of the stack. Complete with lowering lugs.

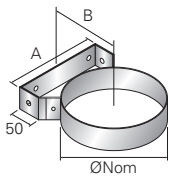

Wall Bracket 50mm

92940

NomØ	80	100	130	150	180	200	230	250	300
A	88	108	142	148	178	198	228	248	298
B	90	100	115	125	140	150	165	175	200

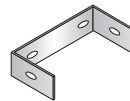

Wall Bracket Extension 50-100mm

95920

ØNom	80	100	130	150	180	200	230	250	300
------	----	-----	-----	-----	-----	-----	-----	-----	-----

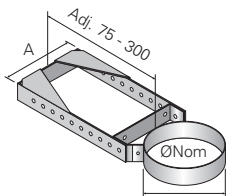

Wall Bracket 300mm Adjustable

95960

ØNom	80	100	130	150	180	200	230	250	300
A	98	118	148	158	188	208	238	258	308

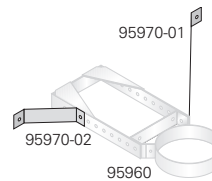

Anti-Swing Stay (Pair)

Short **95970-02**
Long **95970-01**

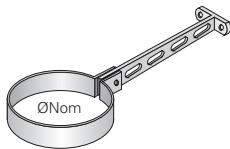

Wall Bracket 300mm Extension

0574

ØNom	80	100	130	150	180	200	230	250	300
------	----	-----	-----	-----	-----	-----	-----	-----	-----

The use of this item enables adjustment of between 50-280mm from the outer surface of the flue to the wall or fixing point

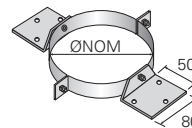

Roof Support

94640

ØNom	80	100	130	150	180	200	230	250	300
------	----	-----	-----	-----	-----	-----	-----	-----	-----

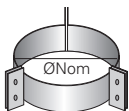

Guy Wire Bracket

95900

ØNom	80	100	130	150	180	200	230	250	300
------	----	-----	-----	-----	-----	-----	-----	-----	-----



Ceiling Hanger

95750

ØNom	80	100	130	150	180	200	230	250	300
------	----	-----	-----	-----	-----	-----	-----	-----	-----

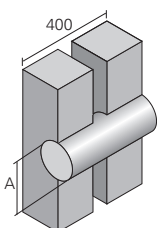

Wall Sleeve

94980

ØNom	80	100	130	150	180	200	230	250	300
A	130	150	180	200	230	250	280	300	350

Flashings

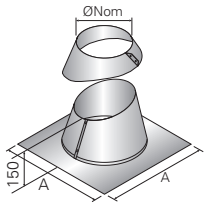

Angled Flashing Kit 5° - 45° 95510

ØNom	80	100	130	150	180	200	230	250	300
A	610	610	610	610	610	700	700	700	800

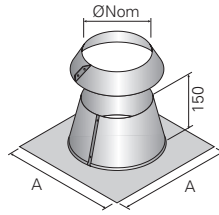

Flat Flashing Kit 5° - 45° 95530

ØNom	80	100	130	150	180	200	230	250	300
A	610	610	610	610	610	610	610	610	610

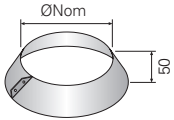

Storm Collar 95560

ØNom	80	100	130	150	180	200	230	250	300
------	----	-----	-----	-----	-----	-----	-----	-----	-----

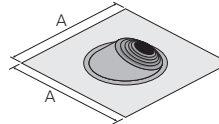

Uniflash

Product Code	94540001	94540002	94540003
Ext Ø (mm)	80-200	150-300	250-450
A	500	685	800

Universal EPDM rubber/aluminium flashing.
Just pull the required diameter tab on the rubber seal.

Prima Plus Terminals

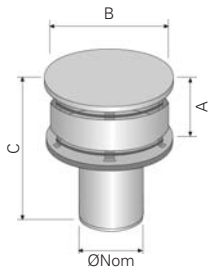

**Anti-Splash
Anti-Downdraught
Terminal
(Gastec Approved)**

with mesh C089
without mesh C095

NomØ	80	100	130	150	180	200	230	250	300
A	95	95	130	175	200	200	250	275	330
B	200	200	254	304	359	409	459	509	609
C	295	295	330	375	400	400	475	475	530

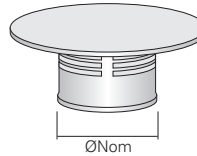

Raincap

P+ S036
P+1 S136

ØNom	80	100	130	150	180	200	230	250	300
------	----	-----	-----	-----	-----	-----	-----	-----	-----

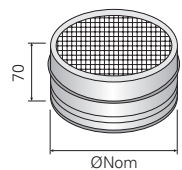

**Open Terminal
(With Mesh)**

S387

ØNom	80	100	130	150	180	200	230	250	300
------	----	-----	-----	-----	-----	-----	-----	-----	-----

Recommended by British Gas for condensing boiler applications.

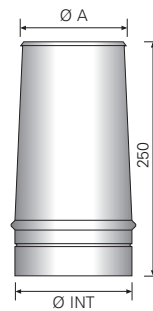

Tapered Terminal

P+ S337
P+1 S437

Ø INT	130	150	180	200	250	300
A	120	140	170	190	240	290

Prima SW Terminals

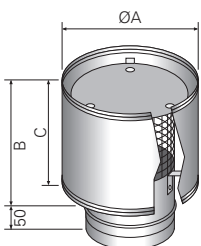

Universal Terminal 0596

Int Ø	100	125	150	180	200	230	250	300
A	265	290	315	345	365	395	415	505
B	300	300	300	300	300	300	300	300
C	220	220	220	220	220	220	220	225

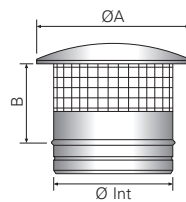

Rain Cap

0540

Int Ø	100	125	150	180	200	230	250	300
A	266	266	266	362	362	362	362	440
B	170	170	170	170	190	200	210	230

Installation

Mandatory Requirements

Connection to an appliance which is not connected to the fuel supply, may be carried out by a competent person. However, connection to an appliance that is connected to the fuel supply must be carried out by a CORGI (gas) or OFTEC (oil) registered installer.

The flue system must be installed to comply with Building Regulations Document J (in England, Wales & Northern Ireland) Regulations for Scotland. The installation must also comply with BS7566 pts 1,2,3,4 for oil flues and BS5440 pt 1: 2000 for gas flues up to 70kw.

Jointing

The components are joined simply by pushing the engineered tolerance male spigot and female socket together until the stop is reached. No sealant is required. Use of a locking band is optional if greater joint security is felt to be required. The female socket should be installed uppermost to ensure any condensate drains smoothly down inside the flue. Terminals should be secured by a locking band or self-tapping screws.

Any flue pipe (i.e. single wall) connection to the chimney must be made in the same room as the appliance. The chimney must project at least 150mm below the ceiling.

Condensing gaskets should be fitted dry and lubricant applied to the female socket (Prima Plus and Prima+ 1mm only).

Adjustable Length

Exact length can be obtained by use of the adjustable pipe and also the 0-90° extendable adjustable bend. Adjustable pipes are not loadbearing therefore adequate support for the system must be provided immediately above.

Adjustable Bend

Adjustable 0-90° bends enable rapid installation and alignment of the flue between appliance and chimney.

Connection to Appliance

Always use an appliance connector, sealed using fire rope and fire cement or high temperature sealant. Connection to a condensing appliance the correct sealant must be used.

Appliance Removal

Use of an adjustable length immediately above the appliance enables removal of the appliance later without dismantling the full system.

Painting

If required to be painted, simply clean the surface with a solvent cleaner (White Spirit), apply a coat of primer and a top coat of high temperature paint that can withstand 550°C. Extreme care must be taken when cleaning with solvent to ensure that it does not come into contact with the gasket if fitted.

Typical Stove Installation showing connection to a Turboflex lined chimney and using the extendable 0-90° bend to align between stove and chimney.

Condensing Boiler with Prima Plus

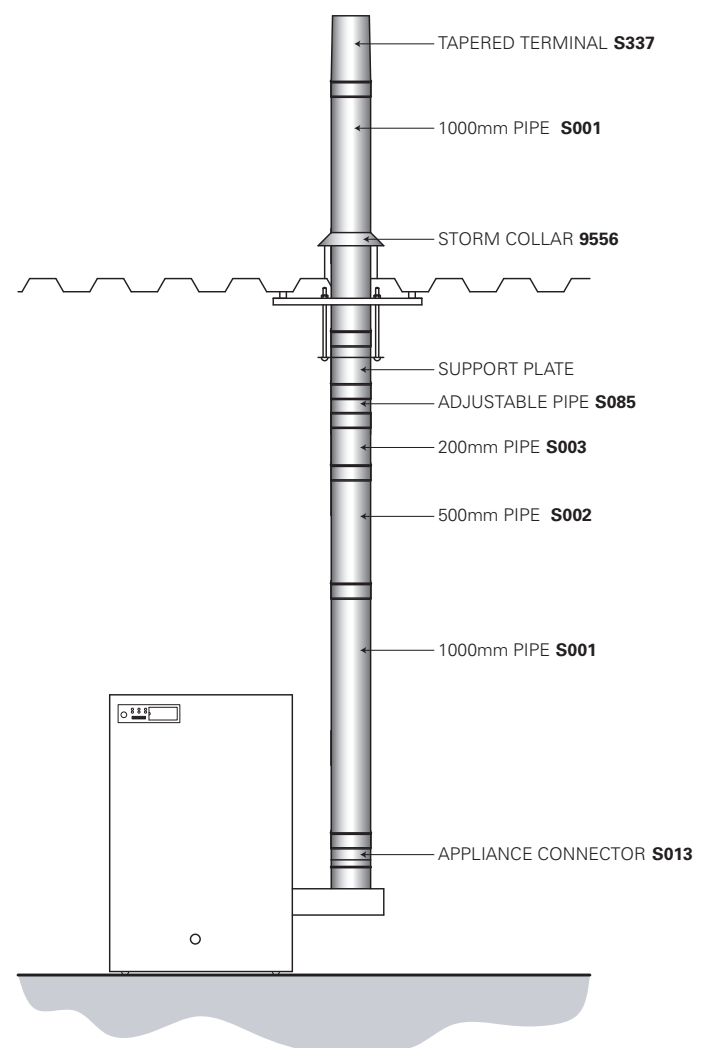

Recommended distance to Combustibles

As a single wall flue system the surface may get very hot and great care should be exercised to avoid touching any exposed section. In accordance with the building regulations (Document J) the outer surface of the flue must be kept from any combustible material the distance as designated in the CE approval.

Support Components

The weight of a chimney system is considerable and requires independent support. No weight should be taken by the appliance. Refer to load bearing table below for full details of maximum loadings.

Load Bearing Data (metres of pipe)

Internal Diameter (mm)	80-130	150-180	200-300
Drain Support	20	20	15
Wall Support	20	20	15
Wall Support (Inv)	25	25	20
90° Tee	15	15	10
135° Tee	10	10	7

Wall brackets and roof brackets are not load bearing and mainly provide lateral support. Wall brackets should be fitted every 3m and at any offset. In domestic situations, a wall bracket or wall support MUST be used to support a tee when connected to a rear outlet appliance.

Horizontal runs should be supported every 1.5m. This can be increased to 4m with use of the extended locking band. Where the flue is free standing above the roof and its height exceeds 1.5m beyond the last support or the roof, a guy wire bracket must be used, and every 1.5m thereafter. Alternatively, a height of up to 3m can be achieved unsupported with the use of an extended locking band at the joint immediately below the last support and every joint above the roof level.

0.6mm Approx Weight of Products (kg)				
Int Dia	Length	1000mm	500mm	250mm
80mm		1.24	0.62	0.31
100mm		1.56	0.78	0.39
130mm		2.01	1.00	0.50
150mm		2.31	1.16	0.58
180mm		2.77	1.39	0.69
200mm		3.08	1.54	0.77
230mm		3.55	1.77	0.89
250mm		3.85	1.93	0.96
300mm		4.63	2.31	1.16

Installation of Prima Plus or a Prima Plus 1mm as a Liner

The liner is lowered into the masonry stack a section at a time using either a lowering pipe or drain support to take the load. It is recommended that pipes are secured to each other using a locking band, or alternatively in non-condensing applications with self-tapping screws or rivets.

The liner requires support at the base of the stack using a wall support, gather unit or drain support. Access to the base of the stack may well be required to fix the support as well as components such as tees and drain caps. Access will also be required to fix any bends necessary in the system. Intermediate support is required if the chimney length exceeds that given in the load-bearing data table. If insulation is required, normally granules such as Vermiculite should be poured in at this stage after fitting a suitable debris plate at the bottom of the system. Alternatively a solid tube of insulation can be used. To weather the top of the chimney stack and seal any gaps between the liner and the chimney pot appropriate acid-resistant mortar should be used.

Gas condensing boiler with Prima Plus

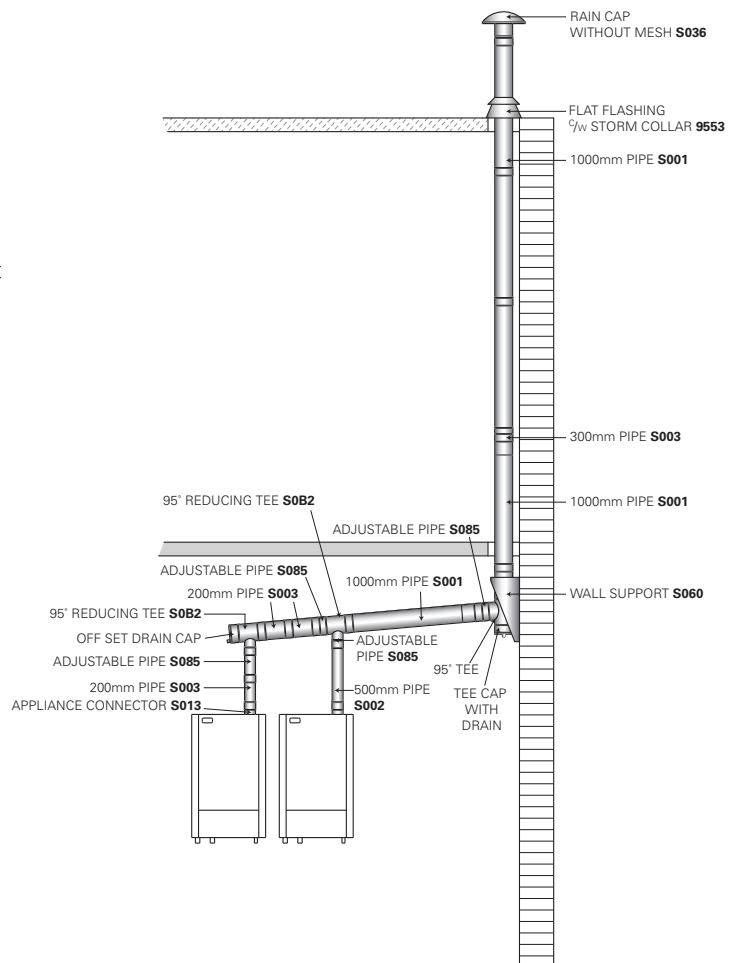

After Installation

Testing before use

This is done by means of flue flow test as described in BS5440:Part 1-2000. It can be summarised as follows:- After a visual and physical check of the joints in the system, and ensuring an adequate air supply for combustion has been provided, close all doors and windows in the room in which the appliance is to be installed. It will be necessary to introduce heat to the flue system for a minimum of 10 mins. and possibly up to 30 mins. using a blow torch or similar. Position a smoke pellet (providing a performance of 5m³ of smoke in 30 secs. burn time) at the intended of the appliance. The test is satisfactory if there is no significant spillage from the appliance position, no seepage over the length of the system, and discharge only from the terminal. If these conditions are not met, the test has failed and all faults must be rectified and the system retested before connection of the appliance to the fuel supply. In the event of any further problems, reference to BS5440:Part 1-2000 must be made.

Life Expectancy

Under normal operating conditions and providing the system is installed correctly, it should last the lifetime of the appliance which is normally 10 to 12 years. Prima Plus carries a 10 year conditional warranty.

The conditions are that the chimney is:

- Correctly sized and installed.
- Properly maintained/cleaned.
- Burning only approved fuels in accordance with the Schiedel Rite-Vent and appliance manufacturer's instructions.

For recommended fuels listings, please refer to the HETAS guide, or by contacting the Solid Fuel Association (Tel: 0845 601 4406) or appliance manufacturer's instructions. Warranty registration details are provided with installation instructions for completion and registration with Schiedel Rite-Vent.

Maintenance

It is essential that the flue way be kept clear at all times in the interest of good practise and health, safety and appliance performance. The system should be checked regularly during the appliance maintenance. (Refer appliance manufacturer's instructions).

Every effort is made to ensure accuracy at time of going to press. However, as part of our policy of continual product development, we reserve the right to alter specifications without prior notice. All installation drawings are graphical representations. Building regulations and relevant British standards must be adhered to.

Fan dilution heater using Prima SW

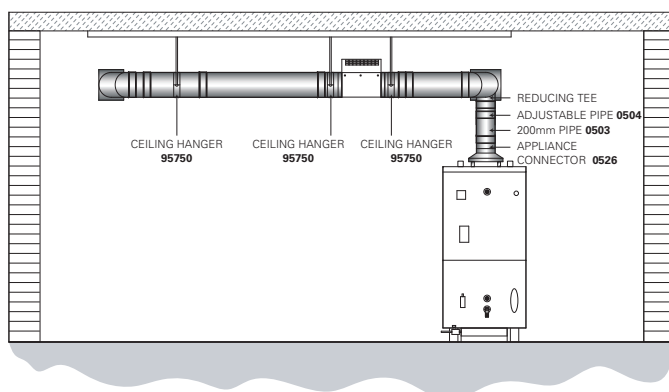
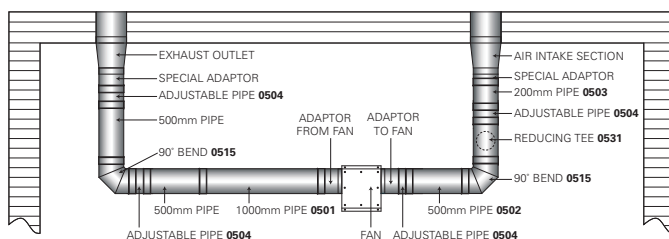

INSTALLER HELPLINE
+44 (0) 191 416 6666

More information on www.rite-vent.co.uk



■ **Prima**

Single wall stainless steel flue system.
80-755mm diameter range.
Prima Plus 1mm for domestic multi fuel stoves and chimney relining.
Prima Plus for large residential and commercial condensing gas and oil appliances.
Prima SW for commercial warm air heaters, gas and oil venting and particle/fume extraction.

Other products in the Schiedel Rite-Vent range



■ **B Vent**

Twin wall gas venting system.
Residential & small commercial applications.
75-150mm internal diameters.
Gas appliances up to 60kw input.



■ **K Vent**

Twin wall insulated venting system for oil (28 sec) and gas appliances.
Residential and small commercial applications.
100-150mm internal diameters.
Oil appliances up to 45kw output.
Gas appliances up to 60kw input.
Interfits with B Vent gas vent.



■ **ICID**

Quick assembly twin wall insulated chimney system for gas, oil, wood and multifuel appliances and open hearths.
Residential and small commercial applications.
125-300mm internal diameters.
Quick assembly twist-lock joint.
For class 1 chimneys, atmospheric and condensing appliances.



■ **ICS**

Twin wall insulated chimney system for gas, oil, wood and multifuel appliances and open hearths
Residential and commercial applications.
80-705mm internal diameters.
For atmospheric, condensing and pressure appliances.
Wet or dry flue and chimney operating conditions.



■ **Flue Boxes**

For installing gas fires and back boilers.
Connection to single and twin skin flexible liners, B Vent, ICS or ICID.
Fast fix spigot for flex connection avoids much of the building work.
Single skin and twin skin air-insulated versions.

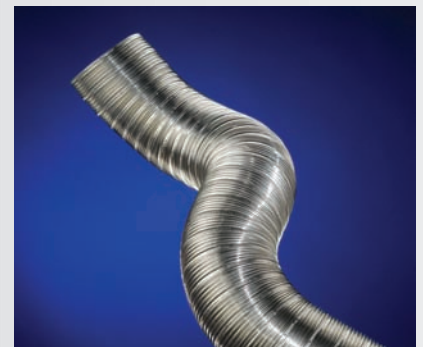

■ **Flexible Liners**

For relining existing chimneys to take gas, oil, wood, multifuel appliances and open fires.
Single skin Wonderflex and Triplelock for gas and oil (28 sec).
Twin skin Turboflex Plus for oil, wood, multifuel and open fires.
80-400mm diameter range.



Schiedel Rite-Vent
Crowther Estate
Washington
Tyne & Wear NE38 0AQ
Tel. +44 (0)191 416 1150
Fax. +44 (0)191 415 1263
sales@rite-vent.co.uk
www.rite-vent.co.uk

Schiedel Chimney Systems
Carrickmacross
Co. Monaghan
Ireland
Tel. +353 (0)42 966 1256
Fax. +353 (0)42 966 2494
office@schiedel.ie
www.schiedel.ie