

RSV *Chimney Fans*

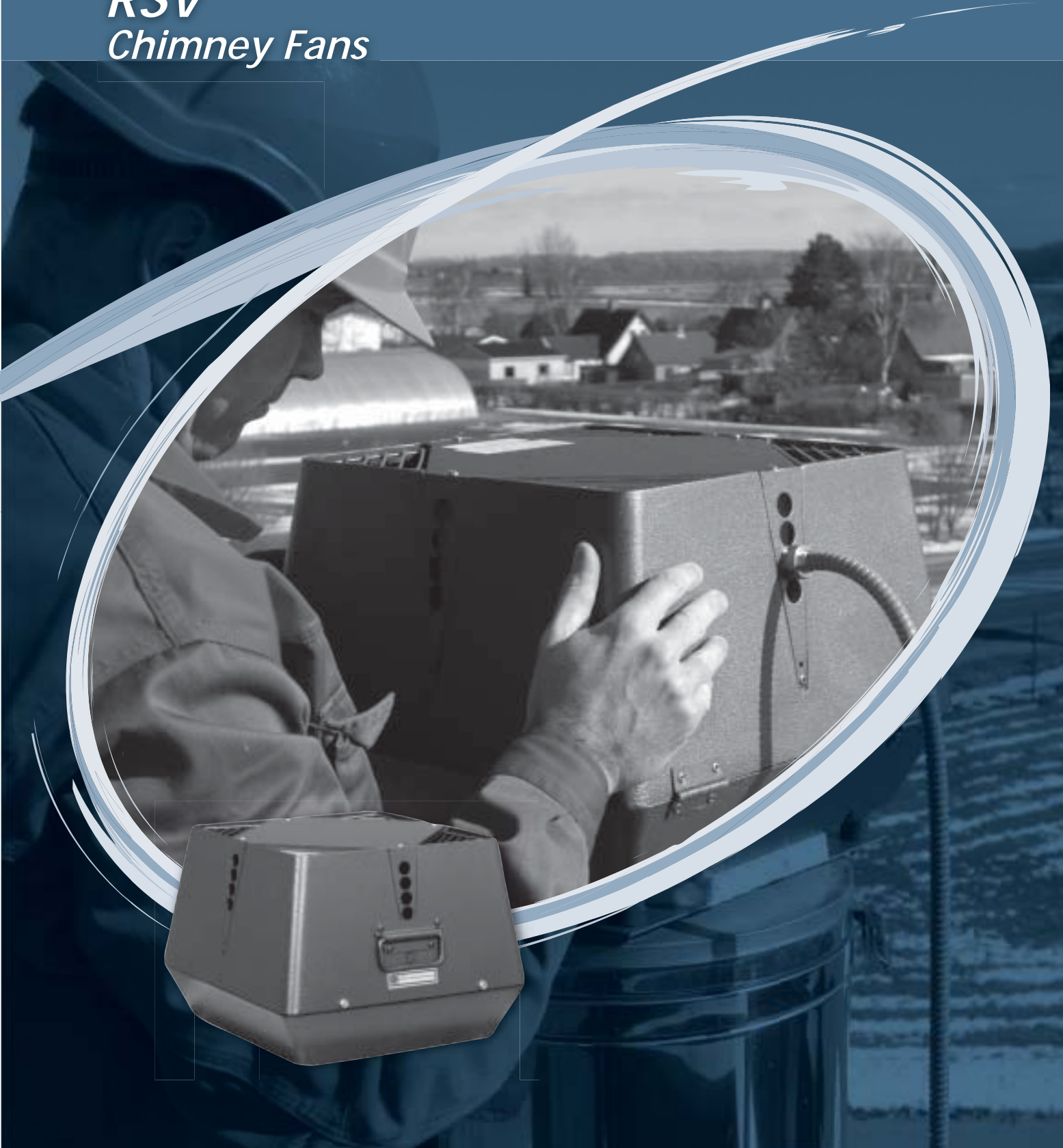

EXHAUSTO

FOR A BETTER FLOW



RSV - Product Information

Description

EXHAUSTO chimney fans RSV are used with heating appliances and provide a controllable negative pressure along the full length of the flue and chimney. The fans guarantee optimum chimney draught irrespective of the placing, dimensions or height of the chimney which is beneficial to new or existing installations.

The chimney fans RSV are normally installed on top of the chimney where the vertical discharge column prevents a plume of gas flowing down the outside of the chimney and thereby complies with the Clean Air Act. The RSV can also be wall mounted.

The fans can be used with appliances burning gas, oil or solid fuel. For solid fuel the fans are supplied with a stainless steel axial vane, which is easy to clean.

For oil or gas the fans are supplied with a backward curved impeller, which gives high fan efficiency.

The chimney fans offer capacities which will cover any heating appliance from small domestic fireplaces to multiple boiler installations with a heat output up to 2MW using a single chimney fan.

Construction

EXHAUSTO chimney fans RSV are constructed of corrosion resistant cast aluminium and are supplied in grey, paint finish. The chimney fans are specially made to withstand flue gas temperatures up to 250°C continuously.

The fans are hinged for easy access for service and maintenance on solid fuel appliances. The fan has a mesh safety guard of stainless steel covering the vertical discharge.

The fans are fitted with an entirely closed, asynchronous motor with ball bearings sealed for life. The motor is specially constructed to provide reliable operation at a high temperature. It is made to international classifications IP54 (degree of protection) and F (insulation). The motor is located inside the motor housing and thus separated from the flue gases.

The electrical connection is provided by a heat resistant silicone cable and is also protected by an armoured sleeve. The motors (1 x 230V) are infinitely adjustable.

EXHAUSTO chimney fans are supplied with a 30 days money-back guarantee.

RSV - Specifications

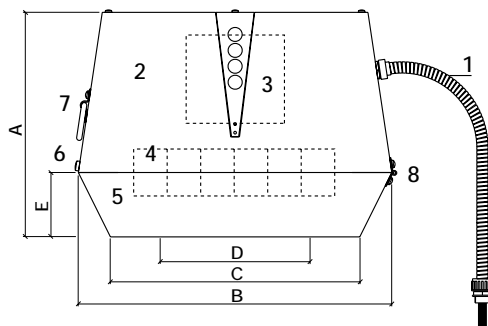

- | | |
|-------------------------------------|-------------------|
| 1. Motor cable | 5. Bottom section |
| 2. Top section | 6. Locking nuts |
| 3. Motor | 7. Handle |
| 4. Axialvane / centrifugal impeller | 8. Hinges |

Model	RPM	1x230V Amp/kW*	Weight kgs	A mm	BxB mm	CxC mm	D ø/mm	E mm
RSV009-4-1	1400	0,2/0,05	13	250	310	240	215	70
RSV012-4-1	1400	0,4/0,07	17	280	390	310	275	80
RSV014-4-1	1400	0,8/0,16	24	335	485	385	335	100
RSV016-4-1	1400	1,8/0,32	35	380	580	465	365	115
RSV160-4-1	1400	0,2/0,05	13	250	310	240	160	70
RSV200-4-1	1400	0,4/0,07	18	280	390	310	200	80
RSV250-4-1	1400	0,8/0,16	27	335	485	385	250	100
RSV315-4-1	1400	1,8/0,37	37	380	580	465	315	115
RSV400-4-1	1400	2,9/0,60	47	430	650	525	400	130

*Max consumption

RSV9, 12, 14 and 16 with axial vane

RSV160, 200, 250, 315, 400 with centrifugal impeller

Ambient temperature: 20°C

RPM is infinitely adjustable for all 1x230 V motors.

Motor protection class IP 54

Insulation class F

The motor must be overload protected.

Sound levels

Sound levels to external surroundings.

Measured in accordance to ISO 3744

Model	Lw (dB)							Lp dB (A)
	125 Hz	250 Hz	500 Hz	1000 Hz	2000 Hz	4000 Hz	8000 Hz	
RSV009-4	57	55	54	49	40	35	26	26
RSV012-4	64	62	61	55	51	46	40	33
RSV014-4	71	70	68	61	56	50	44	40
RSV016-4	76	75	70	65	60	55	49	44
RSV160-4	56	54	57	51	44	34	28	30
RSV200-4	58	60	62	61	56	44	37	36
RSV250-4	64	68	66	65	61	49	45	41
RSV315-4	71	75	70	73	68	57	52	48
RSV400-4	76	80	75	79	74	62	57	53

Tolerance +/-3 db

Lw = Sound effect level dB. (reference: 1 pW)

Lp = Sound Pressure level dB (A) at a distance of 10 m from the fan at halfspheric sound distribution. Lp (20 meter) = Lp (10 meter) - 6 dB.

Lp = (5 meter) = Lp (10 meter) + 6dB

Lp = (20 meter) = Lp (10 meter) - 6dB

Sound levels to flue pipe.

Measured in accordance to ISO 5136

Model	Lw (dB)							Lw dB (A)	Lp dB (A)
	125 Hz	250 Hz	500 Hz	1000 Hz	2000 Hz	4000 Hz	8000 Hz		
RSV009-4	69	58	54	47	41	36	24	56	47
RSV012-4	73	63	61	53	51	46	35	62	54
RSV014-4	78	70	68	60	55	52	42	69	62
RSV016-4	83	75	71	66	62	57	47	72	67
RSV160-4	58	56	58	50	40	31	21	57	49
RSV200-4	65	62	62	58	48	41	30	63	55
RSV250-4	72	69	65	63	56	48	41	68	61
RSV315-4	74	73	70	71	63	53	47	74	69
RSV400-4	76	79	74	76	68	57	50	79	74

Lp = (5 meter) = Lp (10 meter) + 6dB

Lp = (20 meter) = Lp (10 meter) - 6dB

RSV - Discharge velocity

	RSV160	RSV009	RSV012/200	RSV014/250	RSV016/315	RSV400
Capacity at 6m/s (m³/h)		390	655	1052	1500	1925
Discharge velocity at full capacity (m/s)	5,2	6,8	7,7	9,3	11,4	13,0

RSV - Installation

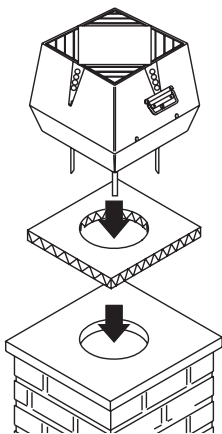

The fan is located on top of the chimney. For the fans RSV9-16 the glass fibre mat must be cut according to the inside diameter of the flue. The fans RSV160-400 are supplied with a pre-cut glass fibre mat corresponding to the chimney fan size.

Locate the location brackets in the grooves on the underside of the fan base plate. The glass fibre mat is placed on top of the chimney with the aluminium foil facing upwards. Locate the fan on top of it.

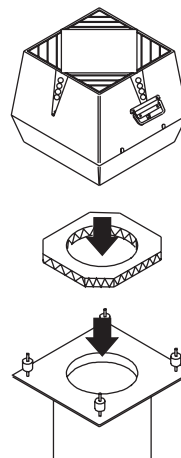

If installed on a metal chimney the fan should be installed with flange type FR and also with anti-vibration bolts instead of location brackets.

When the anti-vibration bolts are used, the corners of the glass fibre mat must also be cut off.

RSV - Maintenance

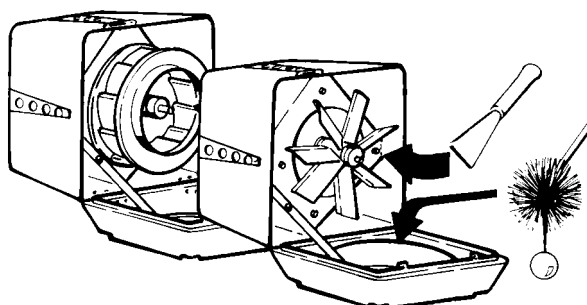

Service and cleaning of the fan should be as required depending on the fuel used (at least once a year on solid fuel). Only burn properly seasoned wood. In open position the hinged chimney fan provides easy access for service and maintenance on solid fuel.

The chimney fan should always operate whenever the heating appliance is used.

RSV - Capacity charts

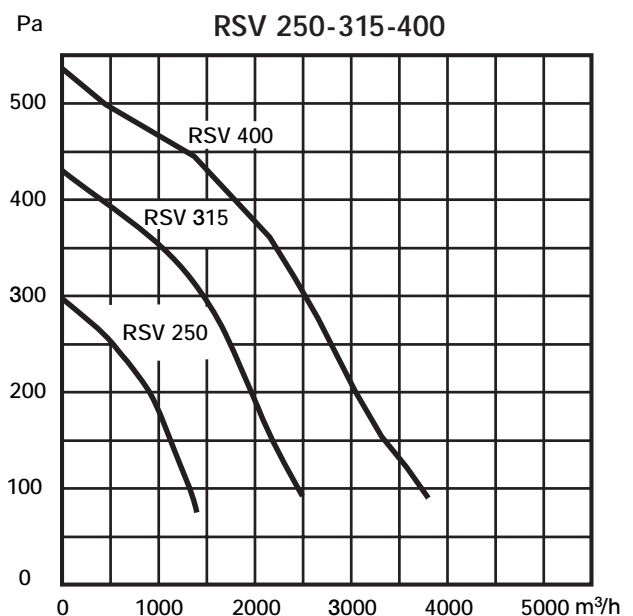
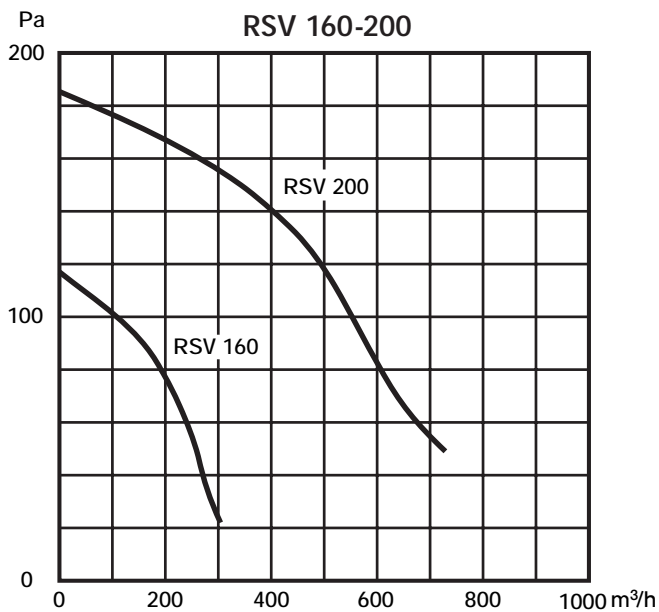
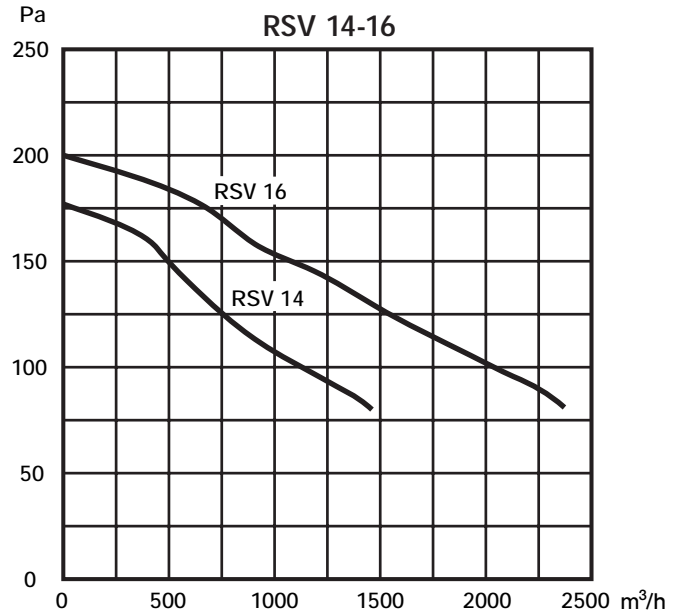
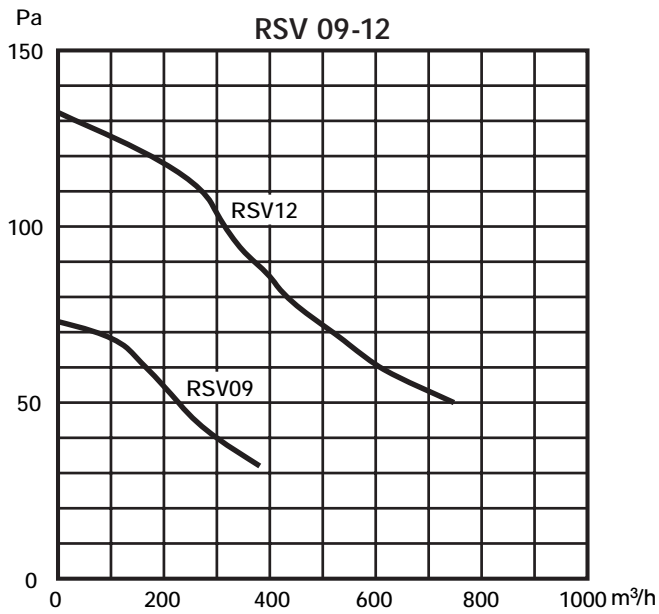

The capacity charts are measured at a flue gas temperature of 20 °C. The fan capacity changes with temperature of the flue gases. Correction of system pressure loss for flue gas temperature higher than 20°C is calculated:

$$P_{s, 20} = P_s \times \frac{273 + t (^{\circ}\text{C})}{293}$$

Example

System demand: 500m³/h and 90 Pa at 180°C
 Chimney fan selection: 500m³/h and 139 Pa at 20°C

RSV - Chimney fan selection

Please use the EXHAUSTO appraisal form.

EXHAUSTO offers a free fan selection service. The correct chimney fan and control unit are calculated according to EN 13384 and DIN 18895.

EXHAUSTO Chimney Fans are supplied with a 2 year warranty. EXHAUSTO is certified according to ISO 9001

EXHAUSTO Ltd.
 Unit 3, Lancaster Court
 Coronation Road
 Cressex Business Park
 GB-High Wycombe - HP12 3TD
 Tel. 01494 465166
 Fax 01494 465163
 info@exhausto.co.uk
 www.exhausto.co.uk

